

INSTRUCTION MANUAL

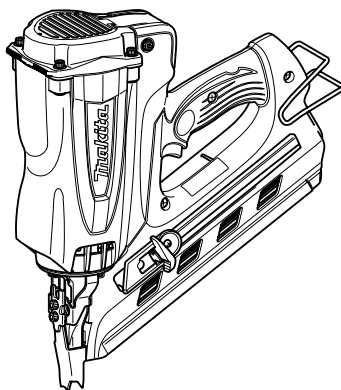

Cordless Clipped Head Framing Nailer

GN900



009440

IMPORTANT: Read Before Using.

ENGLISH (Original instructions)

SPECIFICATIONS

Model	GN900
Nail length X Shank diameter	Nail L :50 mm - 90 mm d : 2.9 mm - 3.3 mm
Nail capacity	40 nails (1strip)
Nail collation angle (degree)	34
Figure of nail head	Clipped
Dimensions (L X H X W)	321 mm X 108 mm X 368 mm
Net weight	3.3 kg
Rated voltage	D.C. 7.2 V

- Due to our continuing programme of research and development, the specifications herein are subject to change without notice.
- Specifications and battery cartridge may differ from country to country.
- Weight, with battery cartridge, according to EPTA-Procedure 01/2003

END107-5

Symbols

The following show the symbols used for the equipment. Be sure that you understand their meaning before use.



- Read instruction manual.



- Container under pressure, keep away from temperatures over 50°C (for ex. sun radiation) Keep container in a well ventilated place.



- Use only outside or well ventilated rooms. Do not breathe gas.



- Do not use near flames or sprays on heated surfaces. In use, may form flammable/explosive vapour-air mixture.



- Do not damage, puncture or burn even after use.



- Wear safety glasses.



- Keep fingers away from trigger when not driving fasteners to avoid accidental firing.



- Use only in ventilated area to avoid nausea and unconsciousness. Never use tool in combustible atmospheres. The tool exhaust may ignite flammable materials.



- Do not use on scaffoldings, ladders.



- Warning: hot surface! Do not touch around this symbol. Touching the surface may cause burns or injuries.



- Only for EU countries Do not dispose of electric equipment or battery pack together with household waste material! In observance of European Directive

2002/96/EC on waste electric and electronic equipment, 2006/66/EC on batteries and accumulators and waste batteries and accumulators and their implementation in accordance with national laws, electric equipment and battery pack that have reached the end of their life must be collected separately and returned to an environmentally compatible recycling facility.

ENE059-1

Intended use

The tool is intended for the preliminary interior work such as fixing floor joists or common rafters and framing work in 2 "x 4" housing.

ENG905-1

Noise

The typical A-weighted noise level determined according to EN792:

Sound pressure level (L_{pA}) : 89 dB(A)

Sound power level (L_{WA}) : 102 dB(A)

Uncertainty (K) : 3 dB(A)

Wear ear protection

ENG904-1

Vibration

The vibration emission value determined according to EN792:

Vibration emission (a_n) : 2.5 m/s^2 or less

Uncertainty (K) : 1.5 m/s^2

ENG901-1

- The declared vibration emission value has been measured in accordance with the standard test method and may be used for comparing one tool with another.
- The declared vibration emission value may also be used in a preliminary assessment of exposure.

⚠ WARNING:

- The vibration emission during actual use of the power tool can differ from the declared emission value depending on the ways in which the tool is used.
- Be sure to identify safety measures to protect the operator that are based on an estimation of exposure in the actual conditions of use (taking account of all parts of the operating cycle such as the times when the tool is switched off and when it is running idle in addition to the trigger time).

ENH003-13

For European countries only

EC Declaration of Conformity

We Makita Corporation as the responsible manufacturer declare that the following Makita machine(s):

Designation of Machine:

Cordless Clipped Head Framing Nailer

Model No./ Type: GN900

are of series production and

Conforms to the following European Directives:

2006/42/EC

And are manufactured in accordance with the following standards or standardised documents:

EN792, EN60745

The technical documentation is kept by our authorised representative in Europe who is:

Makita International Europe Ltd.

Michigan Drive, Tongwell,

Milton Keynes, Bucks MK15 8JD, England

30.1.2009



000230

Tomoyasu Kato

Director

Makita Corporation

3-11-8, Sumiyoshi-cho,

Anjo, Aichi, 446-8502, JAPAN

GEA006-2

General Power Tool Safety Warnings

⚠ WARNING Read all safety warnings and all instructions. Failure to follow the warnings and instructions may result in electric shock, fire and/or serious injury.

Save all warnings and instructions for future reference.

The term "power tool" in the warnings refers to your mains-operated (corded) power tool or battery-operated (cordless) power tool.

Work area safety

1. **Keep work area clean and well lit.** Cluttered or dark areas invite accidents.
2. **Do not operate power tools in explosive atmospheres, such as in the presence of flammable liquids, gases or dust.** Power tools create sparks which may ignite the dust or fumes.
3. **Keep children and bystanders away while operating a power tool.** Distractions can cause you to lose control.

Electrical safety

4. **Power tool plugs must match the outlet. Never modify the plug in any way. Do not use any adapter plugs with earthed (grounded) power tools.** Unmodified plugs and matching outlets will reduce risk of electric shock.
5. **Avoid body contact with earthed or grounded surfaces such as pipes, radiators, ranges and refrigerators.** There is an increased risk of electric shock if your body is earthed or grounded.
6. **Do not expose power tools to rain or wet conditions.** Water entering a power tool will increase the risk of electric shock.
7. **Do not abuse the cord. Never use the cord for carrying, pulling or unplugging the power tool. Keep cord away from heat, oil, sharp edges or moving parts.** Damaged or entangled cords increase the risk of electric shock.
8. **When operating a power tool outdoors, use an extension cord suitable for outdoor use.** Use of a cord suitable for outdoor use reduces the risk of electric shock.
9. **If operating a power tool in a damp location is unavoidable, use a ground fault circuit interrupter (GFCI) protected supply.** Use of an GFCI reduces the risk of electric shock.

Personal safety

10. **Stay alert, watch what you are doing and use common sense when operating a power tool. Do not use a power tool while you are tired or under the influence of drugs, alcohol or medication.** A moment of inattention while operating power tools may result in serious personal injury.
11. **Use personal protective equipment. Always wear eye protection.** Protective equipment such as dust mask, non-skid safety shoes, hard hat, or hearing protection used for appropriate conditions

will reduce personal injuries.

12. **Prevent unintentional starting. Ensure the switch is in the off-position before connecting to power source and/or battery pack, picking up or carrying the tool.** Carrying power tools with your finger on the switch or energising power tools that have the switch on invites accidents.
13. **Remove any adjusting key or wrench before turning the power tool on.** A wrench or a key left attached to a rotating part of the power tool may result in personal injury.
14. **Do not overreach. Keep proper footing and balance at all times.** This enables better control of the power tool in unexpected situations.
15. **Dress properly. Do not wear loose clothing or jewellery. Keep your hair, clothing, and gloves away from moving parts.** Loose clothes, jewellery or long hair can be caught in moving parts.
16. **If devices are provided for the connection of dust extraction and collection facilities, ensure these are connected and properly used.** Use of dust collection can reduce dust-related hazards.

Power tool use and care

17. **Do not force the power tool. Use the correct power tool for your application.** The correct power tool will do the job better and safer at the rate for which it was designed.
18. **Do not use the power tool if the switch does not turn it on and off.** Any power tool that cannot be controlled with the switch is dangerous and must be repaired.
19. **Disconnect the plug from the power source and/or the battery pack from the power tool before making any adjustments, changing accessories, or storing power tools.** Such preventive safety measures reduce the risk of starting the power tool accidentally.
20. **Store idle power tools out of the reach of children and do not allow persons unfamiliar with the power tool or these instructions to operate the power tool.** Power tools are dangerous in the hands of untrained users.
21. **Maintain power tools. Check for misalignment or binding of moving parts, breakage of parts and any other condition that may affect the power tool's operation. If damaged, have the power tool repaired before use.** Many accidents are caused by poorly maintained power tools.
22. **Keep cutting tools sharp and clean.** Properly maintained cutting tools with sharp cutting edges are less likely to bind and are easier to control.
23. **Use the power tool, accessories and tool bits etc. in accordance with these instructions,**

taking into account the working conditions and the work to be performed. Use of the power tool for operations different from those intended could result in a hazardous situation.

Battery tool use and care

24. **Recharge only with the charger specified by the manufacturer.** A charger that is suitable for one type of battery pack may create a risk of fire when used with another battery pack.
25. **Use power tools only with specifically designated battery packs.** Use of any other battery packs may create a risk of injury and fire.
26. **When battery pack is not in use, keep it away from other metal objects, like paper clips, coins, keys, nails, screws or other small metal objects, that can make a connection from one terminal to another.** Shorting the battery terminals together may cause burns or a fire.
27. **Under abusive conditions, liquid may be ejected from the battery; avoid contact. If contact accidentally occurs, flush with water. If liquid contacts eyes, additionally seek medical help.** Liquid ejected from the battery may cause irritation or burns.

Service

28. **Have your power tool serviced by a qualified repair person using only identical replacement parts.** This will ensure that the safety of the power tool is maintained.
29. **Follow instruction for lubricating and changing accessories.**
30. **Keep handles dry, clean and free from oil and grease.**

ENB111-3

IMPORTANT SAFETY INSTRUCTIONS

WARNING: WHEN USING THIS TOOL, BASIC SAFETY PRECAUTIONS SHOULD ALWAYS BE FOLLOWED TO REDUCE THE RISK OF PERSONAL INJURY, INCLUDING THE FOLLOWING:

READ ALL INSTRUCTIONS.

- For personal safety and proper operation and maintenance of the tool, read this instruction manual before using the tool.
- Use the tool only with the Makita genuine fuel cell.
- Never use the tool in enclosed or poorly ventilated spaces.
- Always wear safety glasses to protect your eyes from dust or nail injury.

WARNING:

It is an employer's responsibility to enforce the use of safety eye protection equipment by the tool operators and by other persons in the immediate

working area.

- For Australia and New Zealand only
Always wear safety glasses and face shield to protect your eyes from dust or nail injury. The safety glasses and the face shield should conform with the requirements of AS/NZS 1336.

WARNING:

It is an employer's responsibility to enforce the use of safety eye protection equipment by the tool operators and by other persons in the immediate working area.

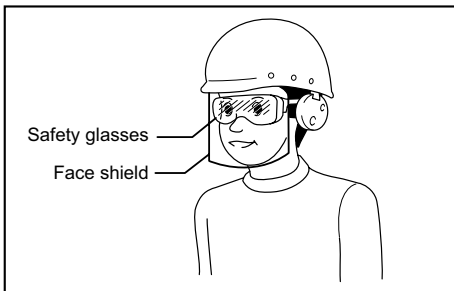

000114

- Wear hearing protection to protect your ears against exhaust noise and head protection. Also wear light but not loose clothing. Sleeves should be buttoned or rolled up. No necktie should be worn.
- Rushing the job or forcing the tool is dangerous. Handle the tool carefully. Do not operate when under the influence of alcohol, drugs or the like.
- General Tool Handling Guidelines:
 - Always assume that the tool contains fasteners.
 - Do not point the tool toward yourself or anyone whether it contains fasteners or not.
 - Do not activate the tool unless the tool is placed firmly against the workpiece.
 - Respect the tool as a working implement.
 - No horseplay.
 - Do not hold or carry the tool with a finger on the trigger.
 - Do not load the tool with fasteners when any one of the operating controls is activated.
 - Do not operate the tool with any power source other than that specified in the tool operating/safety instructions.
- An improperly functioning tool must not be used.
- Sparks sometimes fly when the tool is used. Do not use the tool near volatile, flammable materials such as gasoline, thinner, paint, gas, adhesives, etc.; they will ignite and explode, causing serious injury.
- The area should be sufficiently illuminated to assure safe operations. The area should be clear and litter-free. Be especially careful to maintain good footing and balance.
- Only those involved in the work should be in the vicinity. Children especially must be kept away at all times.
- There may be local regulations concerning noise which must be complied with by keeping noise levels within prescribed limits. In certain cases, shutters should be used to contain noise.
- Do not play with the contact element: it prevents accidental discharge, so it must be kept on and not removed. Securing the trigger in the ON position is also very dangerous. Never attempt to fasten the trigger. Do not operate a tool if any portion of the tool operating controls is inoperable, disconnected, altered, or not working properly.
- Always check the tool for its overall condition and loose screws before operation. Tighten as required.
- Make sure all safety systems are in working order before operation. The tool must not operate if only the trigger is pulled or if only the contact arm is pressed against the wood. It must work only when both actions are performed. Test for possible faulty operation with nails unloaded and the pusher in fully pulled position.
- Check walls, ceilings, floors, roofing and the like carefully to avoid possible electrical shock, gas leakage, explosions, etc. caused by striking live wires, conduits or gas pipes.
- Use only nails specified in this manual. The use of any other nails may cause malfunction of the tool.
- Never use fastener driving tools marked with the symbol "Do not use on scaffoldings, ladders" for specific application for example:
 - when changing one driving location to another involves the use of scaffoldings, stairs, ladders, or ladder alike constructions, e.g. roof laths;
 - closing boxes or crates;
 - fitting transportation safety systems e.g. on vehicles and wagons.
- Do not permit those uninstructed to use the tool.
- Make sure no one is nearby before nailing. Never attempt to nail from both the inside and outside at the same time. Nails may rip through and/or fly off, presenting a grave danger.
- Watch your footing and maintain your balance with the tool. Make sure there is no one below when working in high locations to prevent danger if there is sudden jerking or catching.
- On rooftops and other high locations, nail as you move forward. It is easy to lose your footing if you nail while inching backward. When nailing against perpendicular surface, nail from the top to the bottom. You can perform nailing operations with

less fatigue by doing so.

- A nail will be bent or the tool can become jammed if you mistakenly nail on top of another nail or strike a knot in the wood. The nail may be thrown and hit someone, or the tool itself can react dangerously. Place the nails with care.
- Do not point the ejection port at anyone in the vicinity. Keep hands and feet away from the ejection port area.
- Never carry the tool with your finger on the trigger or hand it to someone in this condition. Accidental firing can be extremely dangerous.
- Handle the tool carefully, as there is high pressure inside the tool that can be dangerous if a crack is caused by rough handling (dropping or striking). Do not attempt to carve or engrave on the tool.
- Stop nailing operations immediately if you notice something wrong or out of the ordinary with the tool.
- Always remove the fuel cell, the battery cartridge and all of the nails:
 - When unattended.
 - Before performing any maintenance or repair.
 - Before cleaning a jam.
 - Before moving the tool to a new location.
- Perform cleaning and maintenance right after finishing the job. Keep the tool in tip-top condition. Lubricate moving parts to prevent rusting and minimize friction-related wear. Wipe off all dust from the parts.
- Do not modify tool without authorization from Makita.
- Ask Makita's Authorized service centers for periodical inspection of the tool.
- To maintain product SAFETY and RELIABILITY, maintenance and repairs should be performed by Makita Authorized Service Centers, always using Makita replacement parts.
- Do not attempt to keep the trigger contact element depressed with tape or wire. Death or serious injury may occur.
- Always check contact element as instructed in this manual. Nails may be driven accidentally if the safety mechanism is not working correctly.

SAVE THESE INSTRUCTIONS.

IMPORTANT SAFETY INSTRUCTIONS FOR BATTERY CARTRIDGE

1. **Before using battery cartridge, read all instructions and cautionary markings on (1) battery charger, (2) battery, and (3) product using battery.**
2. **Do not disassemble battery cartridge.**
3. **If operating time has become excessively shorter, stop operating immediately. It may result in a risk of overheating, possible burns and even an explosion.**
4. **If electrolyte gets into your eyes, rinse them out with clear water and seek medical attention right away. It may result in loss of your eyesight.**
5. **Do not short the battery cartridge:**
 - (1) **Do not touch the terminals with any conductive material.**
 - (2) **Avoid storing battery cartridge in a container with other metal objects such as nails, coins, etc.**
 - (3) **Do not expose battery cartridge to water or rain.**

A battery short can cause a large current flow, overheating, possible burns and even a breakdown.

6. **Do not store the tool and battery cartridge in locations where the temperature may reach or exceed 50 ° C (122 ° F).**
7. **Do not incinerate the battery cartridge even if it is severely damaged or is completely worn out. The battery cartridge can explode in a fire.**
8. **Be careful not to drop or strike battery.**
9. **Do not use a damaged battery.**

SAVE THESE INSTRUCTIONS.

Tips for maintaining maximum battery life

1. **Charge the battery cartridge before completely discharged.**
Always stop tool operation and charge the battery cartridge when you notice less tool power.
2. **Never recharge a fully charged battery cartridge.**
Overcharging shortens the battery service life.
3. **Charge the battery cartridge with room temperature at 10 ° C - 40 ° C (50 ° F - 104 ° F). Let a hot battery cartridge cool down before charging it.**

Overview of the nailer

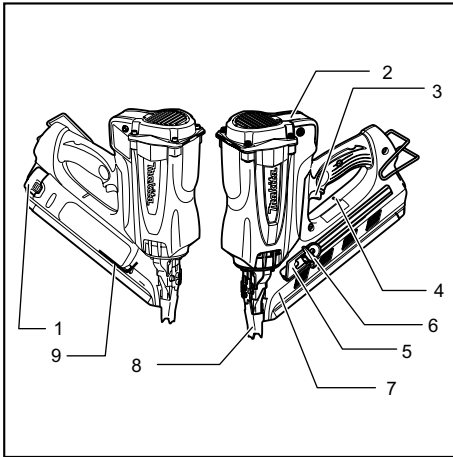

1. Battery cartridge
2. Fuel cover
3. Trigger
4. Indication lamp
5. Pusher lever
6. Pusher button
7. Magazine
8. Contact element
9. Hex wrench

009459

FUNCTIONAL DESCRIPTION

⚠CAUTION:

- Always be sure to remove the fuel cell, the battery cartridge and nails before adjusting or checking function on the tool.

Installing or removing battery cartridge

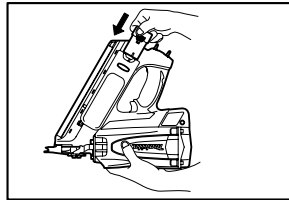

009441

- Always switch off the tool before insertion or removal of the battery cartridge.
- To remove the battery cartridge, withdraw it from the tool while pressing the button on the side of the cartridge as shown in the figure.

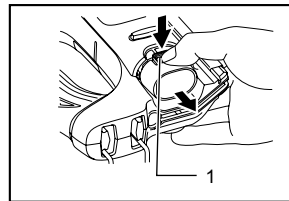

1. Button

009444

- To insert the battery cartridge, hold it so that the battery cartridge front shape fits to that of the battery installment opening and slip it into place. Always insert it all the way until it locks in place with a little click. If not, it may accidentally fall out of the tool, causing injury to you or someone around you.
- Do not use force when inserting the battery cartridge. If the cartridge does not slide in easily, it is not being inserted correctly.

Fuel cell

Attaching the metering valve to the fuel cell

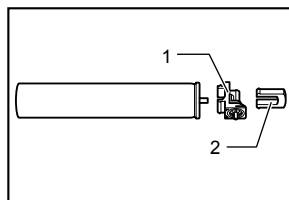

1. Metering valve
2. Cap

009445

Detach the cap (in case the metering valve is provided with the cap).

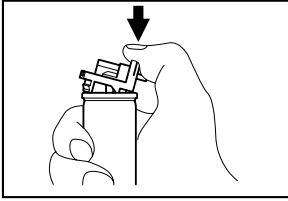

009446

Push in the front edge.

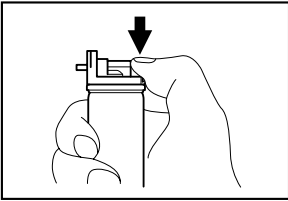

009447

Push in the rear edge until it seats.

Inserting the fuel cell

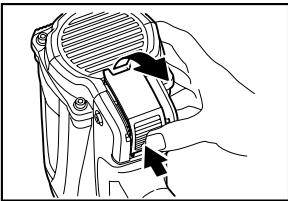

009448

Push up and pull the fuel cover to open.

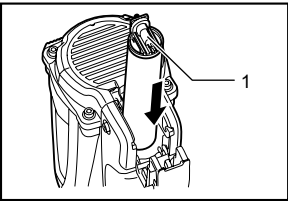

009449

Insert the fuel cell directing the jet nozzle of the metering valve toward the adaptor.

1. Jet nozzle

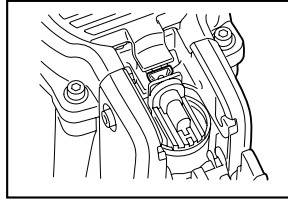

009450

Insert the jet nozzle into the small hole of the adaptor properly.

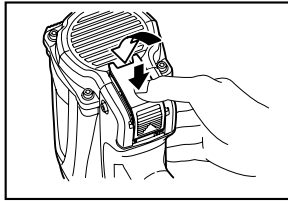

009451

Put the fuel cover over the metering valve and push it down to latch.

Adjusting the nailing depth

⚠CAUTION:

- Remove the fuel cell, the battery cartridge and nails before adjusting the depth of nailing.

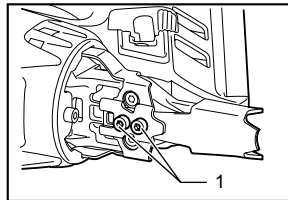

1. Screws

009456

With the hex wrench, loosen two screws and move the contact element.

Retighten screws firmly.

Indication lamp

Color of the indication lamp means the followings.

Blinking green: Normal status

Blinking red: Need to recharge the battery cartridge

Lighting-up-red: Recharge the battery cartridge. Nailing cannot be performed due to no remaining battery capacity.

Blinking orange after blinking green and red alternately: Fault detection is running. Remove and reinsert the battery cartridge to reset. If fault detection is running again, it is malfunction condition.

Installing the hook

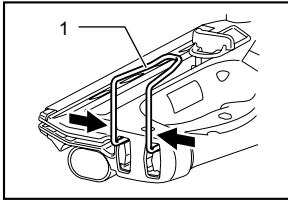

1. Hook

009457

The hook is convenient for hanging the tool temporarily. The hook can be set in two positions according to where the tool will be hung.

To change the hook position, contract it at its foot by pushing in from both sides and shift to another position.

ASSEMBLY

⚠CAUTION:

- Always remove the fuel cell and the battery cartridge.

Loading the nailer

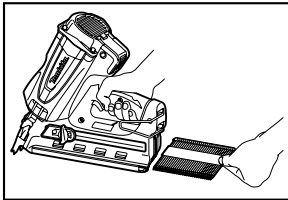

009442

Insert a strip of nails into the slit in the rear of the magazine.

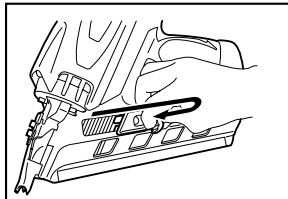

009452

Pull the Pusher Lever to the rear of the Magazine and return it to the end of the strip gently.

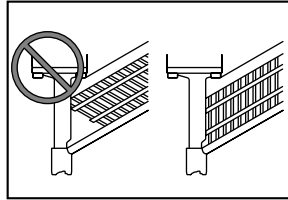

011695

Load nails so that they get parallel to the driver guide.

Removing nails

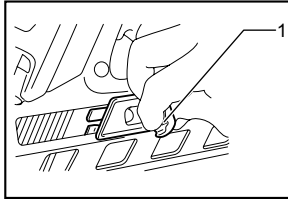

1. Pusher button

009453

Pull the pusher lever and push the pusher button to release the nail supporter, and then return the pusher lever to the top pushing the pusher button.

Slide the nails toward the rear of the magazine and remove them out.

OPERATION

⚠WARNING:

- **Do not touch around the exhaust vent.** The surface will be so hot during or after an operation. Touching around the exhaust vent may cause burns or injuries.

⚠CAUTION:

- Make sure all safety systems are in working order before operation.

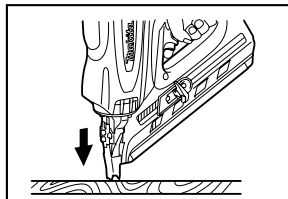

009454

1. To drive a nail, place the contact element against the workpiece.

The fan motor is activated, fuel gas is injected into combustion chamber and mixed with air by the fan.

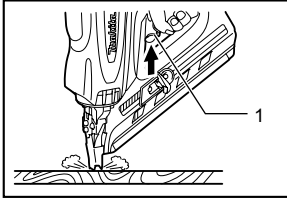

1. Trigger

009455

2. Hold the contact element pressing firmly and pull the trigger.

Fuel gas is combusted and the nail is driven.

3. Further driving can be initiated only after both the contact element and the trigger are released.

Anti dry fire mechanism

This is the mechanism that the tool prevents to be fired without nail.

Dry fire prevention automatically sets up when the rest of nails get to last 4-7 pieces.

Jammed nailer

⚠CAUTION:

- Always be sure to remove the fuel cell and the battery cartridge before clearing a jam.

When the nailer gets jammed, do as follows.

1. Remove the fuel cell, the battery cartridge and nails.

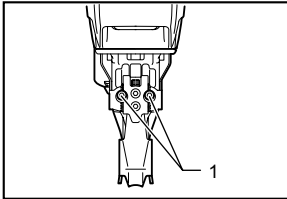

1. Screws

009460

2. Loosen the (2) magazine mounting screws with the hex wrench.

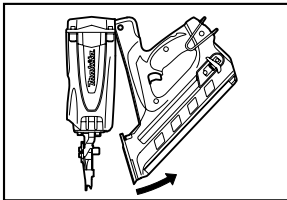

009443

3. Pull the handle/magazine away from the nose of the tool and clear jam.
4. Realign the handle/magazine to the nose and tighten mounting screws.
5. Reload a strip of nails.

⚠WARNING:

- Make sure that the magazine mounting screws are tight and the magazine is tight to the nose. Attempting to fire tool with a loose magazine will result in loss of nail control, damage to the tool or nail discharge toward operator.

MAINTENANCE

⚠CAUTION:

- Always remove the fuel cell, the battery cartridge and nails before attempting to perform inspection or maintenance.
- Never use gasoline, benzene, thinner, alcohol or the like. Discoloration, deformation or cracks may result.

Cleaning the air filter

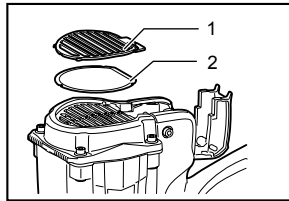

1. Filter cover
2. Filter

009456

Press slightly up the fuel cover and pivot it open. And then remove the filter cover and simply lift out the filter.

Tap the filter lightly to remove any dust. Soap and water restores the filter to an almost new condition

Maintenance after daily work

At the end of daily work, conduct an end-of-workday routine.

These simple steps are based on maintaining the safety and performance of Makita Cordless Clipped Head Framing Nailer

Before leaving the work site:

1. Remove the battery cartridge and store in a tool-carrying case. Always use the Cordless Clipped Head Framing Nailer case for transporting and storing the tool.
2. Dispose of all empty fuel cells. Remember to dispose of these cells where they will not be found by children, crushed, punctured or burned.

When you get home:

- (1) Place the battery cartridge in its charger if it needs charging as indicated by the red indication lamp near the handle.
- (2) Wipe your Cordless Clip Head Framing Nailer with a clean, soft cloth.
- (3) Check the filter and clean if it is dusty.

To maintain product SAFETY and RELIABILITY, repairs, any other maintenance or adjustment should be performed by Makita Authorized Service Centers, always using Makita replacement parts.

OPTIONAL ACCESSORIES

CAUTION:

- These accessories or attachments are recommended for use with your Makita tool specified in this manual. The use of any other accessories or attachments might present a risk of injury to persons. Only use accessory or attachment for its stated purpose.

If you need any assistance for more details regarding these accessories, ask your local Makita Service Center.

- Nails
- Safety goggles
- Fuel cell
- Cleaning kit
- Various type of Makita genuine batteries and chargers

NOTE:

- Some items in the list may be included in the tool package as standard accessories. They may differ from country to country.

Makita Corporation
Anjo, Aichi, Japan

884862D228

www.makita.com